

Technical Brochure

# LTG Air-Water Systems

Decentralised ventilation units  
*FVP* *pulse* -V

**pulse**  
ventilation

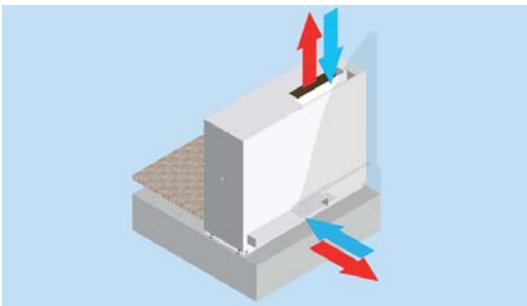

Sill installation

## Technical brochure

### Decentralised ventilation units *FVPpulse -V*, sill installation

LTG Comfort Air Technology	
	
Air Diffusers	
Air Distribution	

#### Content

	Page
General description	4
Dimensions	6
Technical data	7
Example configurations	8
Ventilation concepts	10
Regulation, control	12
Assembly	20

#### Notes

Dimensions stated in this brochure are in mm.

Dimensions stated in this brochure are subject to General Tolerances according to DIN ISO 2768-vL. For the outlet grille special tolerances stated in the drawing apply.

Straightness and twist tolerances for extruded aluminium profiles according to DIN EN 12020-2.

The surface finish is designed to meet the requirements for applications in buildings - room climate according to DIN 1946 part 2. Other requirements on request.

The actual tender documentations are available in word format at your local dealership or at [www.LTG.net](http://www.LTG.net).

#### LTG planning tools – we support you!

**Ask for your own** DVD with helpful tools, such as dimensioning programs, streaming videos and product information! Also available: our product overviews about air-water systems, air diffusers and air distribution products.

Visit us on [www.LTG.net](http://www.LTG.net) and get detailed technical information as PDF files at „Download“.



*FVP-V\_eng\_TP (02/17)*

## Technical brochure

### Decentralised ventilation units *FVPpulse -V*, sill installation

# LTG Decentral

## Dezentralised Ventilation Units

### Flexible and energy-efficient!

### Decentralised Ventilation Units with highly efficient heat recovery

Decentralised Ventilation Units offer unique flexibility in combination with high operational efficiency for architects and planners.

All ventilation is provided locally. Both supply and exhaust air flows are guided across the façade and conditioned to suit design conditions. An integrated, highly efficient heat recuperator minimises the heating/cooling losses to ensure low energy costs.

Without a central AHU, decentralised systems offer the only, highly efficient solution to renovate existing buildings in an energy-efficient manner. Local systems offer an innovative and energy-efficient means for individual, demand-controlled air conditioning for new construction projects as well

LTG Aktiengesellschaft offers units for local air conditioning for all installation situations in the ceiling, the façade and the false floor.

### LTG System PulseVentilation

The *FVPpulse* pulsed facade-mounted ventilation unit reproduces the natural movement of the air and allows buildings to „breathe“. Unlike conventional facade-mounted ventilation units, *FVPpulse* uses a shared air duct for both the supplied and waste air, a **single** facade opening and only **one** fan. Thanks to a system of dampers, it switches between the intake and outlet functions – without causing any airstream short-circuits !

### Benefits

- No central air conditioning plant or duct system required
- Lower floor height possible for reduced construction costs and efficient use of space
- High user acceptance provided by individual control
- High energy efficiency provided by demand-controlled ventilation with heat recovery
- Latest innovation:  
Decentralised solution with pulsating flow in the new *FVPpulse* System PulseVentilation



This non-stationary ventilation results in the thorough mixing of the air in the room at low air velocities and high air volumes and consequently ensures an agreeable room climate. Important for architects and investors: *FVPpulse* units need fewer main components than conventional facade-mounted ventilation solutions and are more compact, while still offering the same level of performance.

## Technical brochure

# Decentralised ventilation units *FVPpulse -V*, sill installation

### Application

The *FVPpulse* is a decentralized 4-pipe ventilation unit for installation in false floors that is used to ventilate and extract air from occupied areas directly via the facade. It is also used to heat and cool the outside air and offers a highly efficient heat recovery system. This decentralized ventilation unit is the ideal choice for areas in which high air quality and thermal comfort are important criteria.

### Installation, positioning

Setup on floor. Tolerances of unfinished floor compensated for using adjustable unit feet.

Connection of water pipes underneath the unit on the left-hand side (when viewed from the room). Connection using flexible hoses in an oxygen-diffusion-proof design, with stainless steel braiding and any required connection on the customer side.

Condensate connection is also underneath the unit on the left-hand side (when viewed from the room).

Unit width 320 mm

Unit height 800 mm (unit feet completely screwed in)

Unit length 990 mm

### Advantages

- Pulsed flow to provide air conditioning with highly efficient ventilation and thermal comfort
- Economical solution thanks to the low capital investment and operating costs
- Only one opening in the facade, extremely easy to integrate in the building without airstream short-circuits
- Extremely reliable operation thanks to innovative design and control concepts

### Specifications

All components comply with VDI 6022.

#### Housing

Manufactured from galvanized sheet steel, black coating in visible area. With punched openings for water pipes and electrical connections.

#### Heat exchanger

Manufactured from a corrosion-resistant aluminium alloy (EN AW 8006). Water-side connection G ½" female thread. Permitted water-side working pressure: 12 bar, 2-pipe or 4-pipe system.

#### Heat recovery unit

Highly efficient class H1 regenerator as per DIN EN 13053. The lamellae are manufactured from a corrosion-resistant aluminium alloy (EN AW 8006). The unit cannot freeze up during its cyclical mode of operation because the surface temperature of the regenerator fluctuates periodically about a mean value. Heat recovery levels of up to 90 % depending on the cycle time. Air filter for intake and exhaust air.

The ventilation unit is equipped with an intake air filter (filter class: F7) with information plate indicating the filter type, inspection interval and time of last filter replacement, as well as with an exhaust air filter (similar to G2).

#### Fan

Low-noise radial fan with energy-saving, highly efficient EC motor (SFP class 1, < 500 W/m<sup>3</sup>/s)

#### Facade-mounted damper / Internal sealing of the unit

In the event of a power failure, the facade-mounted damper is closed automatically (VDMA 24390) thanks to an actuating drive equipped with capacitors. Leakage air flow (relative to circumference of damper): Class 3

#### Acoustic and thermal insulation

The silencers are made from low-flammability insulating materials (B1) with a closed-pore cover layer. They are rot-proof and resistant to the formation of mould or mildew.

#### Condensate

The alternating air flow prevents condensation in the heat recovery unit.

## Technical brochure

# Decentralised ventilation units *FVPpulse -V*, sill installation

### Design of the unit, mode of operation

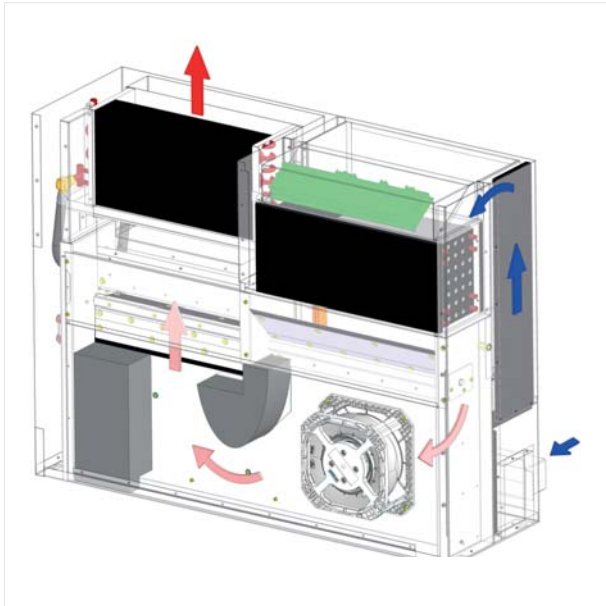

*Breathing IN (in winter)*

#### **Breathing IN in winter (air supply mode)**

Function: The heat recovery unit is still warm from the outlet cycle. The Breathing IN cycle now starts: the outside air is drawn in through the facade opening and supply air filter.

1. The outside air flows through the heat recovery unit and is heated.
2. The air passes through the fan's inlet chamber (lower level).
3. The EC fan transports the air from the inlet chamber (lower level) into the pressure chamber (upper level).
4. In the upper level, the supplied air passes through the silencer.
5. Here, it passes through the damper and into the supply air duct.
6. After leaving the supply air duct, the air is cooled or heated by the heat exchanger and is discharged out through a supply air grille.

The flow is reversed by switching over the damper.

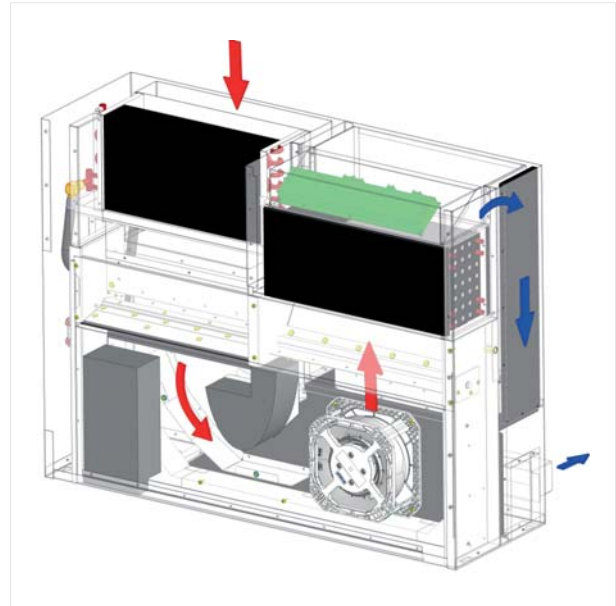

*Breathing OUT (in winter)*

#### **Breathing OUT in winter (exhaust air operation)**

1. The waste air is drawn out of the room via the heat exchanger bypass and the „exhaust air filter“.
2. The air passes through the damper and into the suction chamber (lower level).
3. In the suction chamber, the air flows to the EC fan (lower level).
4. The EC fan transports the air from the suction chamber (lower level) into the pressure chamber (upper level).
5. The warm air flows through the damper to the heat recovery unit where its energy is transferred to this unit.
6. The exhaust air is now evacuated to the outside via the facade opening.

Technical brochure

Decentralised ventilation units *FVPpulse -V*, sill installation

Dimensions (example 2-pipe system)

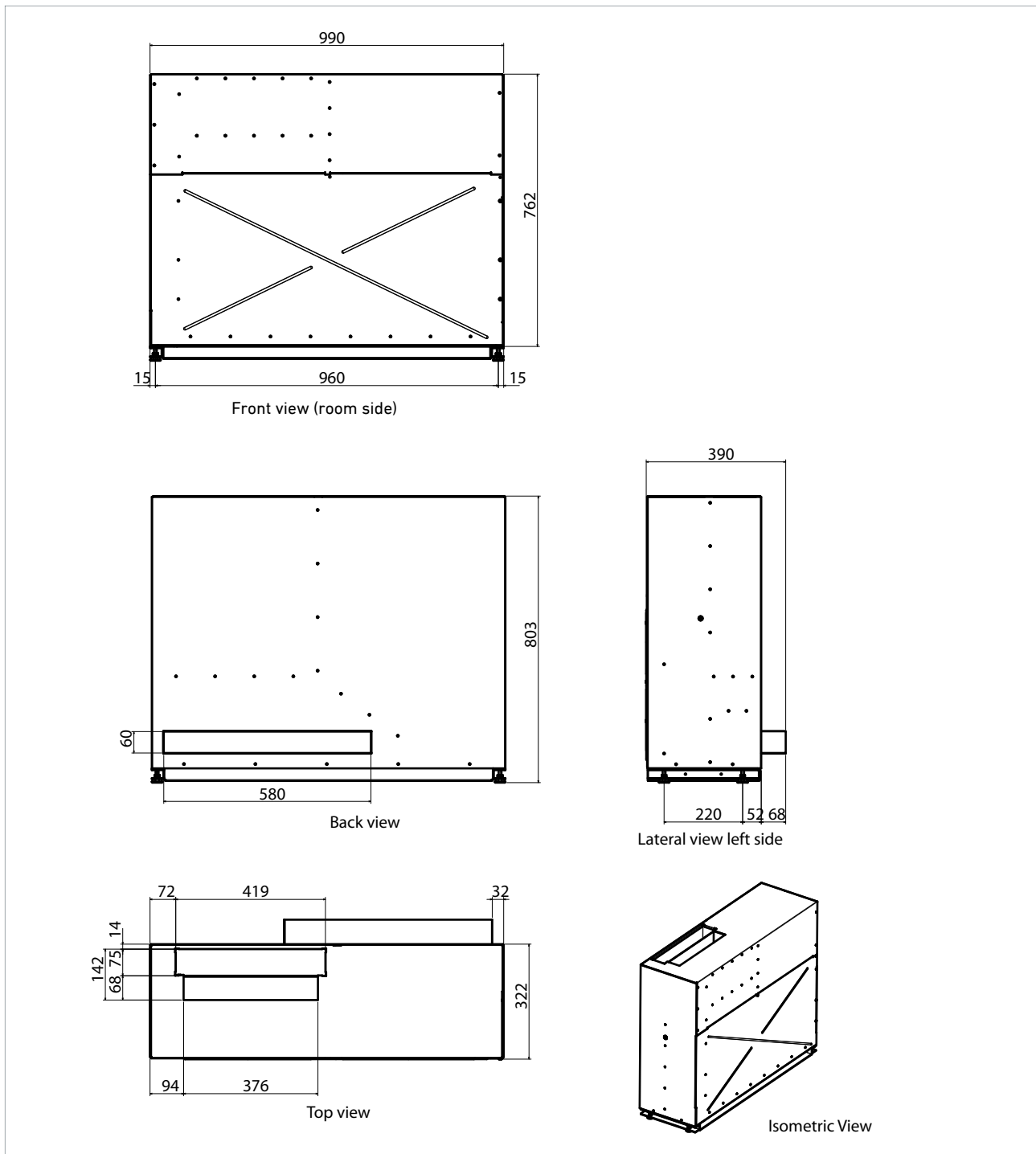

## Technical brochure

### Decentralised ventilation units *FVPpulse -V*, sill installation

#### Technical data 2-pipe system, cycle time 2 x 20 s

$P_{el}^{4)}$	$L_{WA}$	$V$	Heating				Cooling				$w_{OH}$	$w_{OK}$
			$Q_{H, ges}^{1)}$	$Q_{H, Raum}^{1)}$	$T_{H, ZU}^{1)}$	$T_{H, RL}^{1)}$	$Q_{K, ges}^{2)}$	$Q_{K, Raum}^{2)}$	$T_{K, ZU}^{2)}$	$T_{K, RL}^{2)}$		
[W]	[(dB(A))]	[m <sup>3</sup> /h]	[W]	[W]	[°C]	[°C]	[W]	[W]	[°C]	[°C]	[kg/h]/[kPa]	[kg/h]/[kPa]
42	48	260 <sup>3)</sup>	-	-	-	-	-1018 <sup>3)</sup>	-498 <sup>3)</sup>	20 <sup>3)</sup>	20 <sup>3)</sup>	100 / 3	200 / 6
37	46	240 <sup>3)</sup>	-	-	-	-	-976 <sup>3)</sup>	-496 <sup>3)</sup>	20 <sup>3)</sup>	20 <sup>3)</sup>		
25	43	200 <sup>3)</sup>	-	-	-	-	-874 <sup>3)</sup>	-474 <sup>3)</sup>	19 <sup>3)</sup>	20 <sup>3)</sup>		
16	40	160 <sup>3)</sup>	-	-	-	-	-748 <sup>3)</sup>	-428 <sup>3)</sup>	18 <sup>3)</sup>	19 <sup>3)</sup>		
37	46	120	2451	1091	49	48	-562	-322	18	18		
25	43	100	2147	1014	52	49	-487	-287	18	18		
16	40	80	1806	899	56	51	-405	-245	17	17		
9	35	60	1432	752	60	53	-314	-194	16	17		
4	29	40	1028	575	60	54	-217	-137	16	17		

- 1) At 60 °C water supply temperature, -12 °C outside air temperature, 22 °C room temperature, heat recovery level 76...82 %, free intake without external pressure loss
- 2) At 16 °C water supply temperature; 32 °C outside air temperature, 26 °C room temperature, non-condensing operation, heat recovery level 78...82 % free intake without external pressure loss
- 3) Hybrid ventilation: In the summer, the waste air can be evacuated via a window left ajar. In this case, the unit operates continuously in air supply mode. This almost doubles the unit's cooling capacity and the fresh air volume without causing any change to noise emissions. However, no heat recovery is possible.
- 4) The electrical power input, including for regulation during ventilation operation.

- $P_{el}$  - Electrical power input
- $L_{WA}$  - Acoustic power level  $\pm$  3 dB(A)
- $V$  - Flow rate
- $Q_{H, tot}$  - Heating capacity of unit, incl. heat recovery
- $Q_{H, room}$  - Available room heating capacity
- $T_{H, zu}$  - Supply air temperature in heating mode
- $T_{H, RL}$  - Water return temperature in heating mode
- $Q_{K, tot}$  - Cooling capacity of unit, incl. heat recovery
- $Q_{K, room}$  - Available room cooling capacity
- $T_{K, zu}$  - Supply air temperature in cooling mode
- $T_{K, RL}$  - Water return temperature in cooling mode
- $w_{oh}$  - Nominal water volume for heating
- $w_{ok}$  - Nominal water volume for cooling

## Technical brochure

### Decentralised ventilation units *FVPpulse -V*, sill installation

#### Cooling capacity

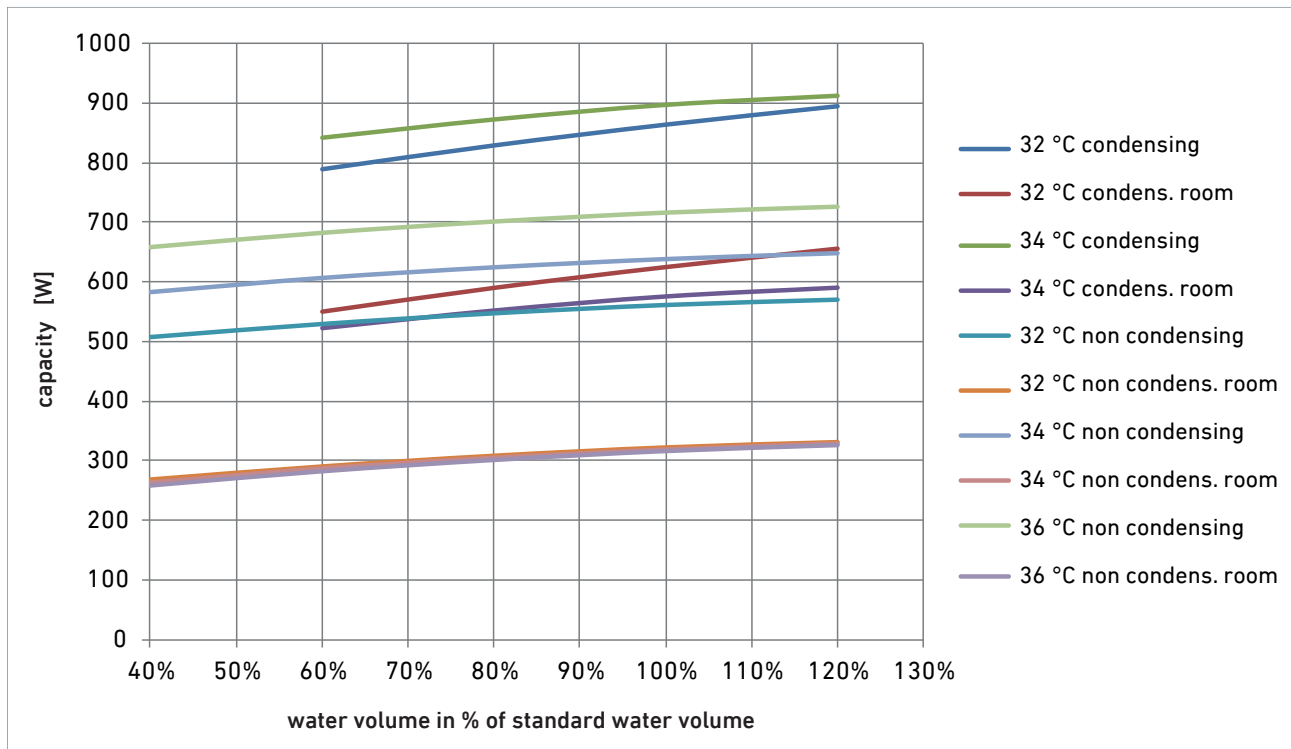

#### Heating capacity

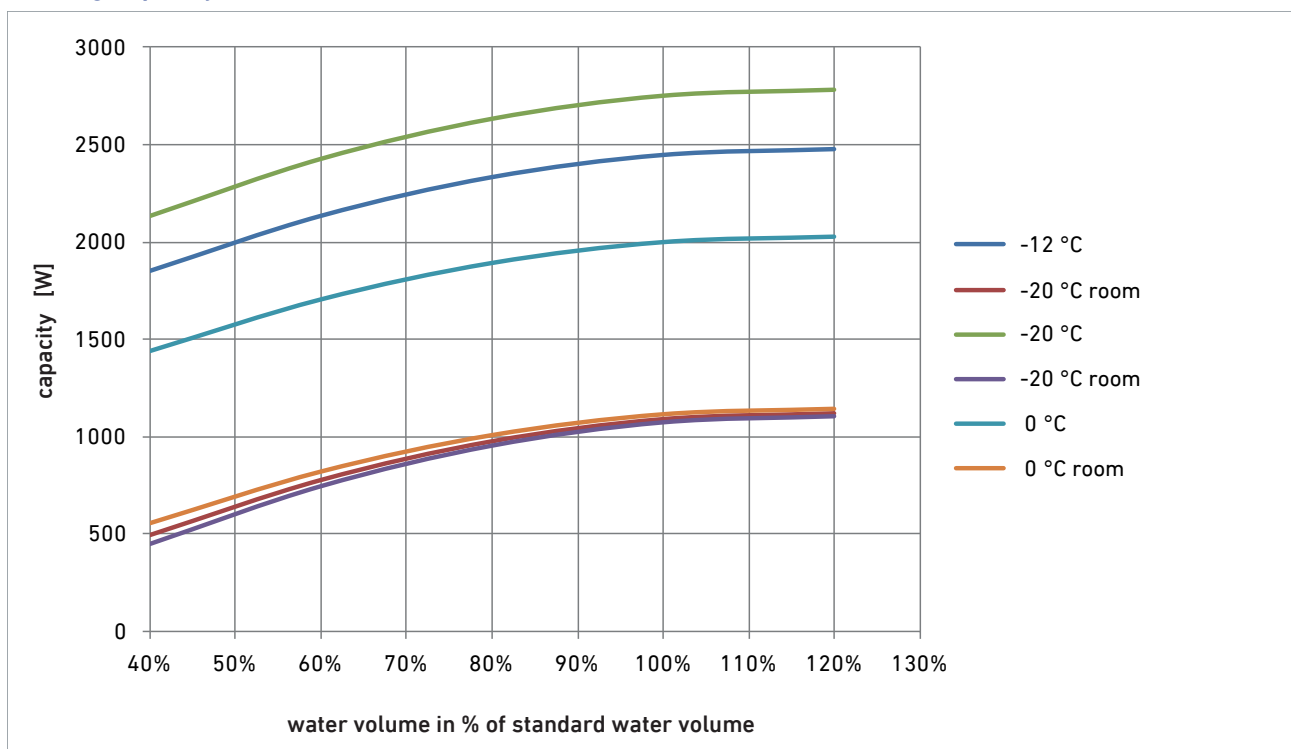



## Technical brochure

### Decentralised ventilation units *FVPpulse -V*, sill installation

#### Water-side pressure loss of cooling/heating capacity at different water volumes

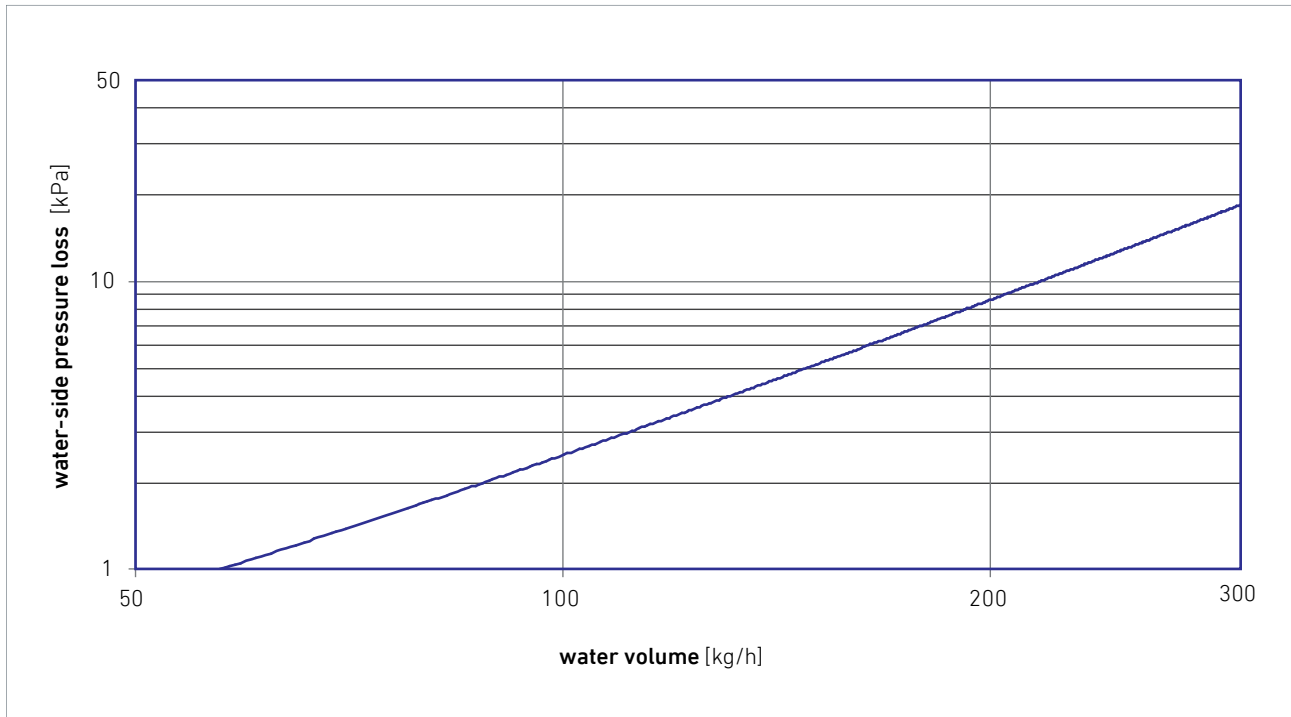

#### Heat recovery level as a function of cycle time

One cycle consists of:

- Supply operation
- Switchover from supply to exhaust operation
- Exhaust operation

Standard cycle time 40 s:

- 19 seconds supply operation
- 2 seconds switchover
- 19 seconds exhaust operation

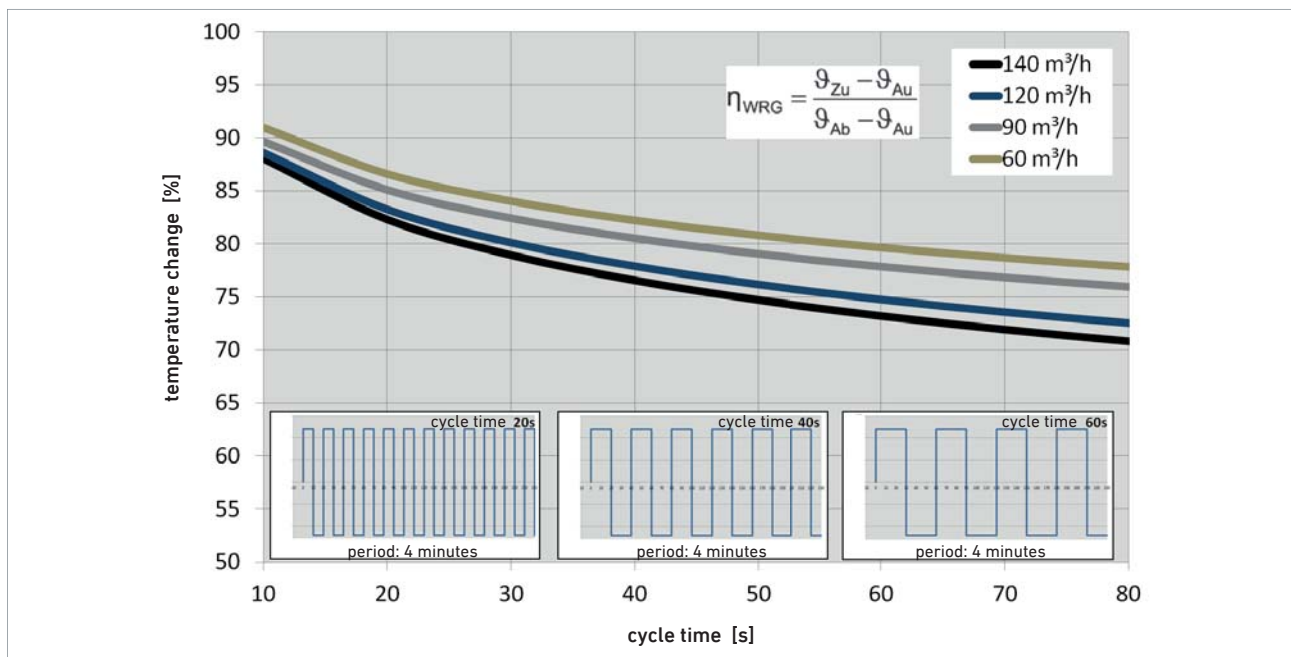

## Technical brochure

# Decentralised ventilation units *FVPpulse -V*, sill installation

### „Demand-controlled ventilation“ ventilation concept

A CO<sub>2</sub> switch, presence or movement sensor registers the ventilation requirement (for the control concepts, see page 12).

#### 1st possibility: One unit per room

The transient ventilation system causes pressure fluctuations in the room. These pressure fluctuations can be balanced out using soundproofed overflow ports (supplied by LTG, page 11). This also permits the decentralized ventilation of indoor areas.

In the first cycle (Figure 1), one unit takes air in, while the other unit is evacuating air.

Following the switchover, the intake/outlet operation is inverted (Figure 2). Ideally, the two reciprocating units should communicate with one another during this process (master-slave communication).

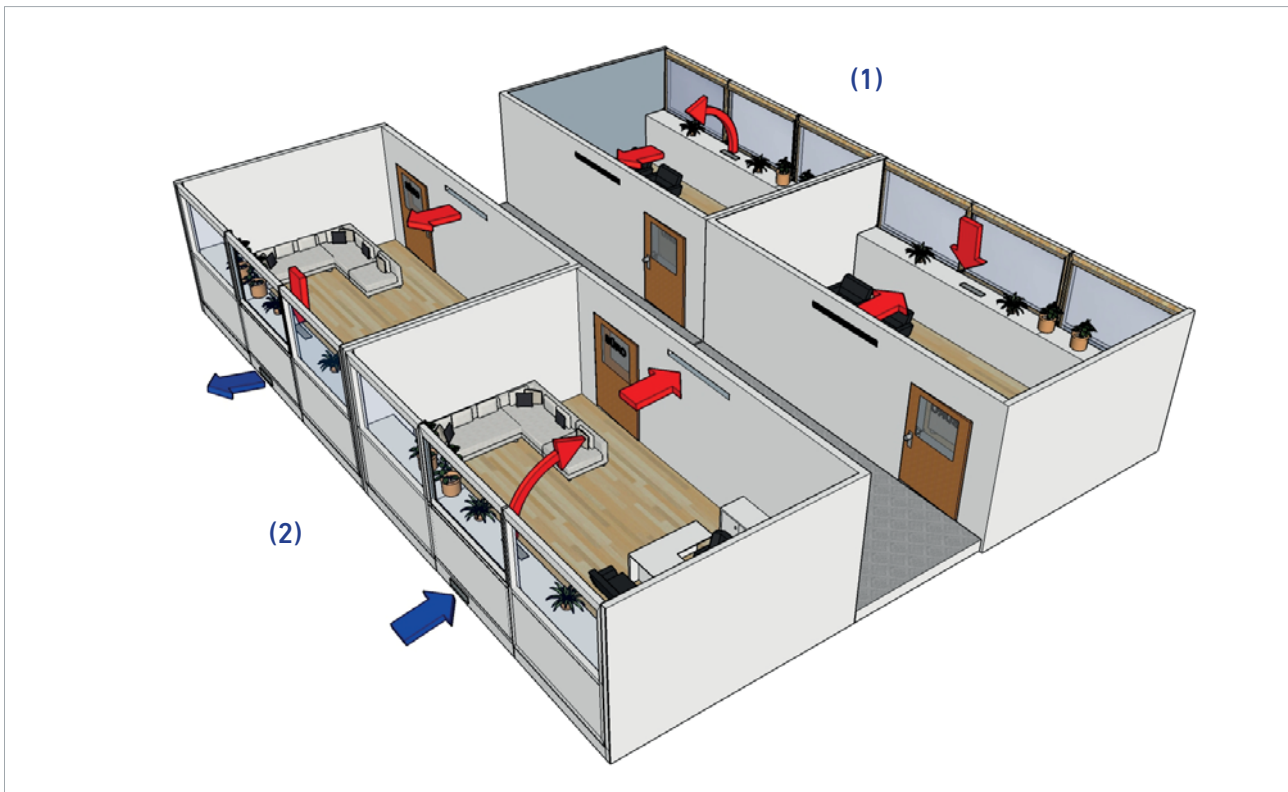

#### 2nd possibility: Two units per room

If two units are installed in each room then an overflow port is no longer required.

The units can be connected together within a „master-slave configuration“ in such a way that one unit draws air into the room while the other unit evacuates it again. In this configuration, one master unit is connected to at most one slave unit.

Because the units operate cyclically in alternation, no over-pressure or under-pressure occurs in the room.

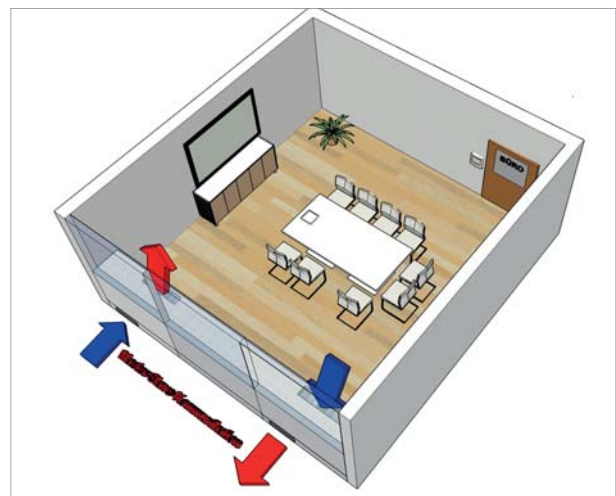

## Technical brochure

### Decentralised ventilation units FVP-V, sill installation

#### Dimensions of transfer air device LDO-T

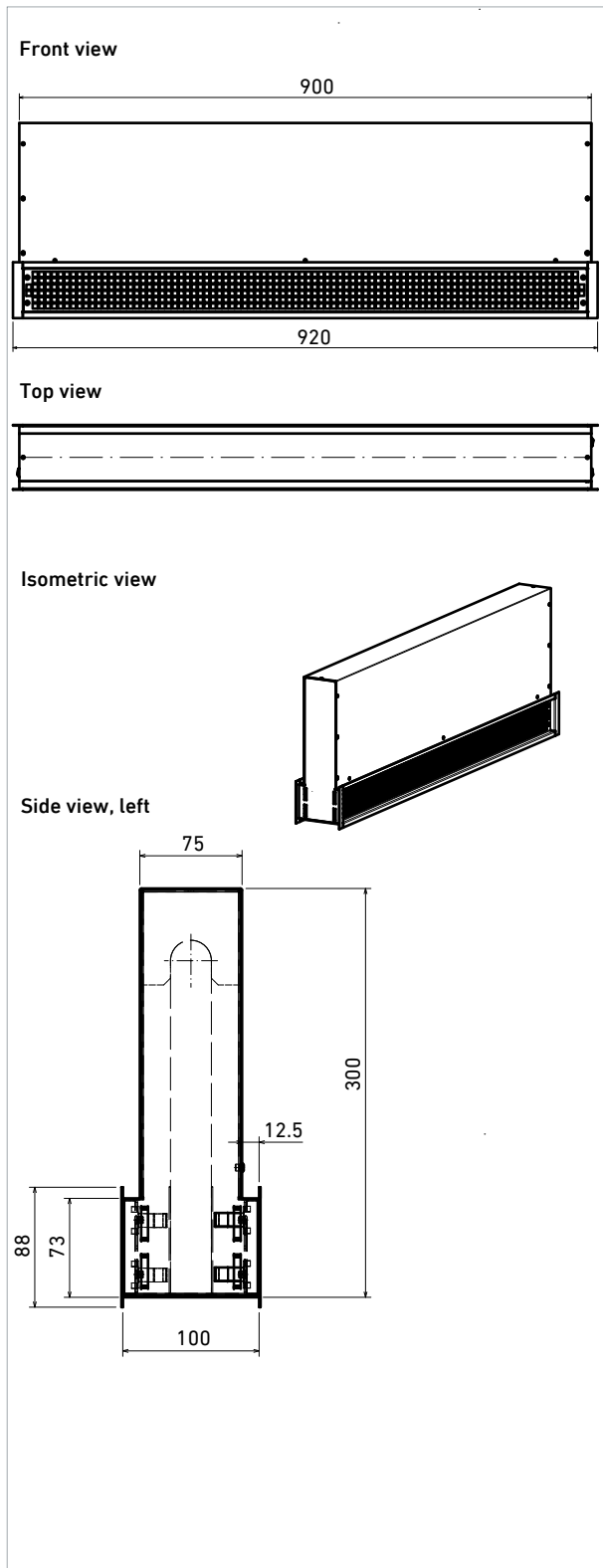

#### „Hybrid ventilation“ ventilation concept

It is possible to pass 240 m<sup>3</sup>/h of clean supplied air through the unit. Hybrid ventilation is used to respond to the needs of peak cooling loads in the summer. When hybrid ventilation is used, the unit acts as a simple supply air unit. The waste air can be evacuated through a window left ajar, for example. This almost doubles the cooling capacity of the unit as well as the fresh air volume without increasing noise emissions.

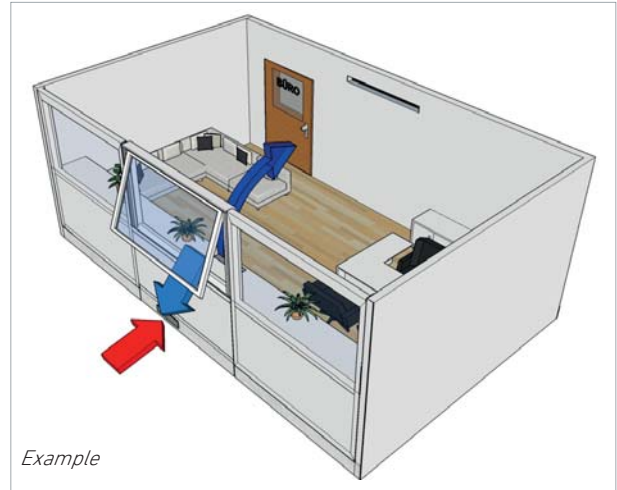

#### „Night-time ventilation“ ventilation concept

In night-time ventilation, the units are switched to a stationary operating mode. The units must be controlled in such a way that one unit takes air in while the unit opposite is evacuating air (in the case of master-slave communication, it is not necessary to control the slave unit separately). In this way, the building can be ventilated and cooled on cool summer nights without having to leave any windows open. The heat recovery function is therefore not active. For the control mechanism, see page 18.

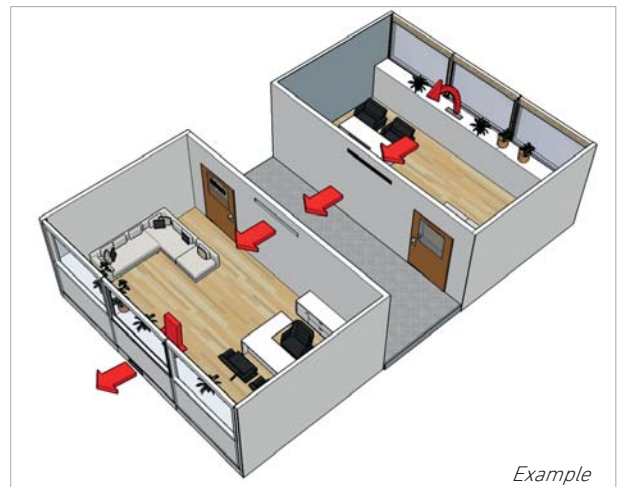



## Technical brochure

# Decentralised ventilation units *FVPpulse -V*, sill installation

### Example ECO regulation/control

#### Simple control diagram with room and building control system (GLT) options

It is also possible, for example, to activate the ventilation concepts via the building control system. To this end, the unit possesses 230 V inputs for the activation of the ventilation concepts. The unit does not possess a direct communications interface.

#### Controlling the hybrid ventilation

Hybrid ventilation should only be activated during the summer months. It is possible, for example, for a window contact to communicate with the building control system which then records the request and only permits the corresponding response during the summer months.

#### Controlling the night-time ventilation

Night-time ventilation is used for free cooling. It should be activated as appropriate by the building control system (GLT) when there is a significant difference between the room temperature and the outside air temperature on cool summer nights.

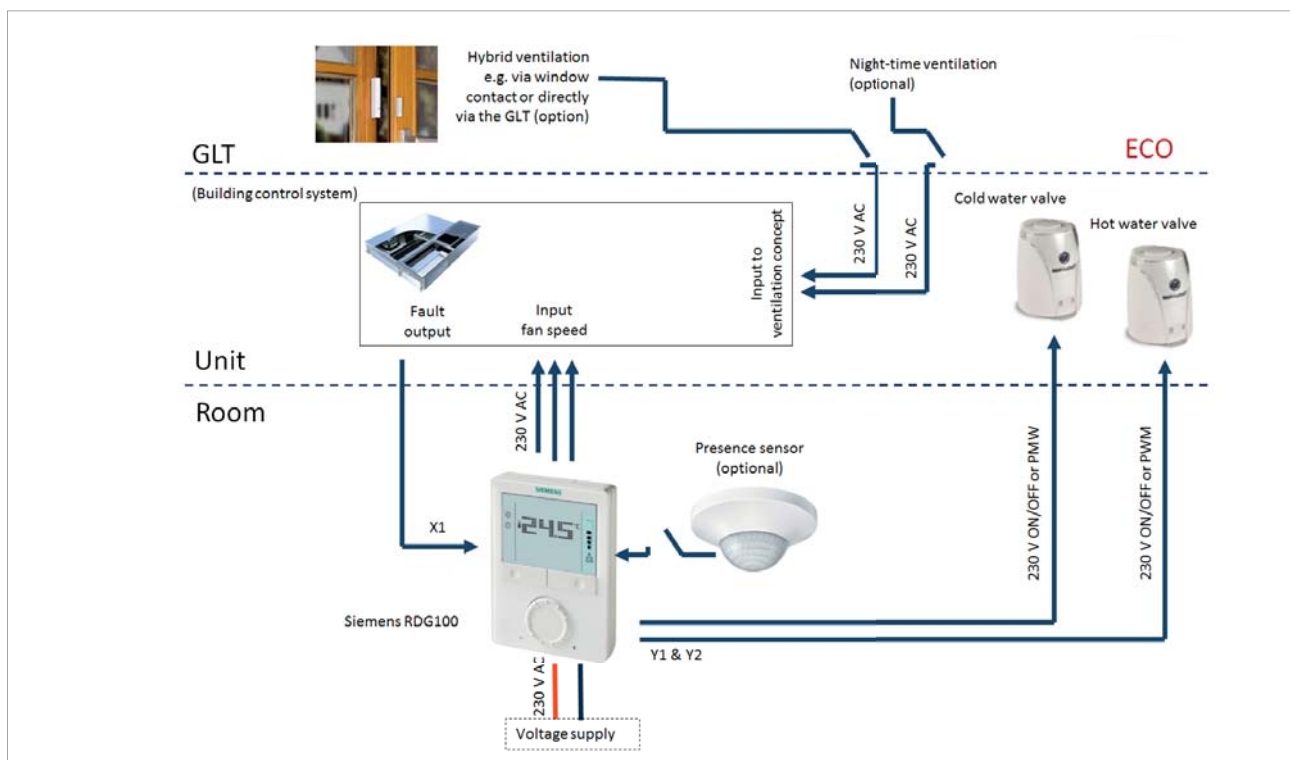

## Technical brochure

# Decentralised ventilation units *FVPpulse -V*, sill installation

### Premium regulation/control

The Premium regulator/control offers the same capabilities as the ECO regulator/control, together with the following **additional** functions.

#### Wind pressure control

An intelligent control mechanism adapts the transported supply and exhaust volume flows accordingly when there is an under-pressure or over-pressure at the facade. In the *FVPpulse* ventilation unit, this is achieved through the asynchronous control of the supply and exhaust air flows.

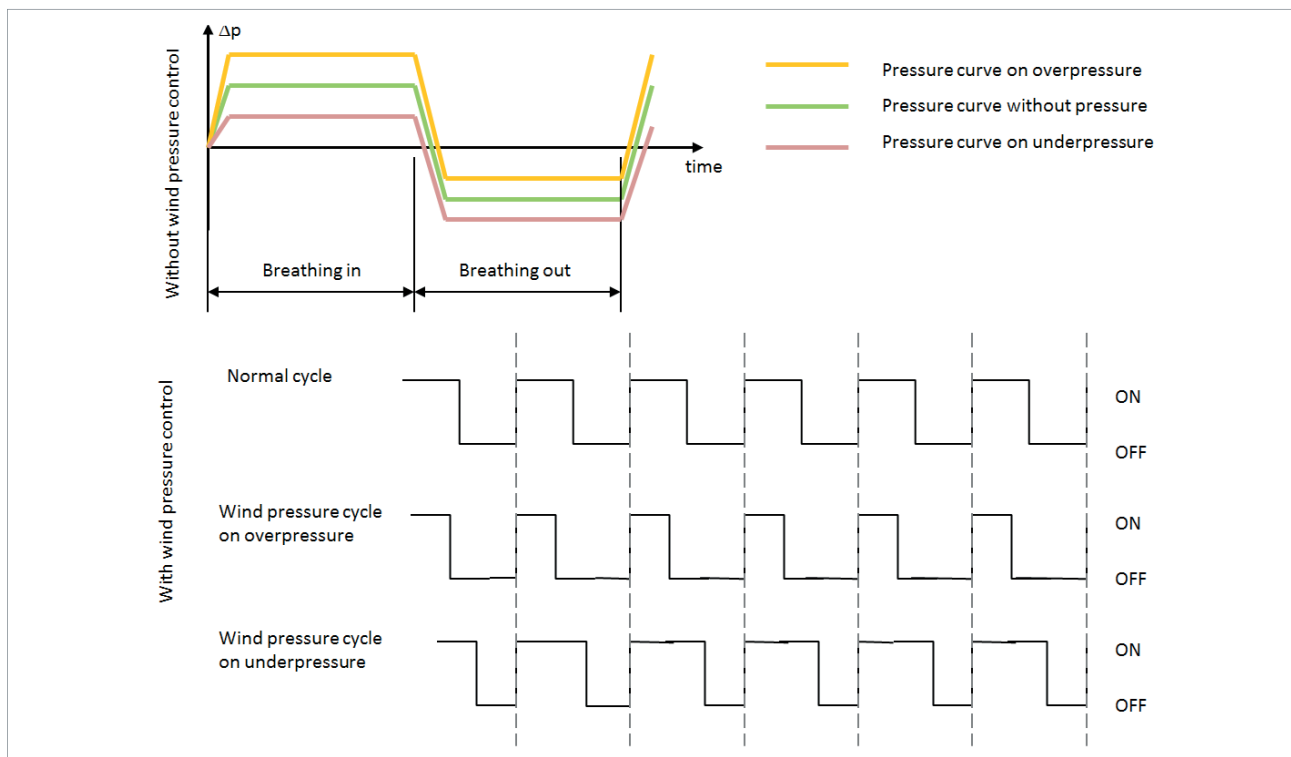

#### Continuous flow rate control

The flow rate can be adjusted continuously from 0...120 m<sup>3</sup>/h via an analogue signal (0...10 V DC) both in stationary mode (either only supplied air or only exhaust air, 0...240 m<sup>3</sup>/h) and in non-stationary mode.

#### Continuous adjustment of the cycle time

The cycle time for supplied and waste air transport can be adjusted continuously from 10...80 s by means of an analogue signal (0...10 V DC). This results in the heat recovery levels indicated in the diagram on page 9.

## Technical brochure

### Decentralised ventilation units *FVPpulse -V*, sill installation

#### Example Premium regulator/control: Demand-controlled ventilation with the RDG 160 KNX room temperature controller

Simple control diagram with room and building control system (GLT) options:

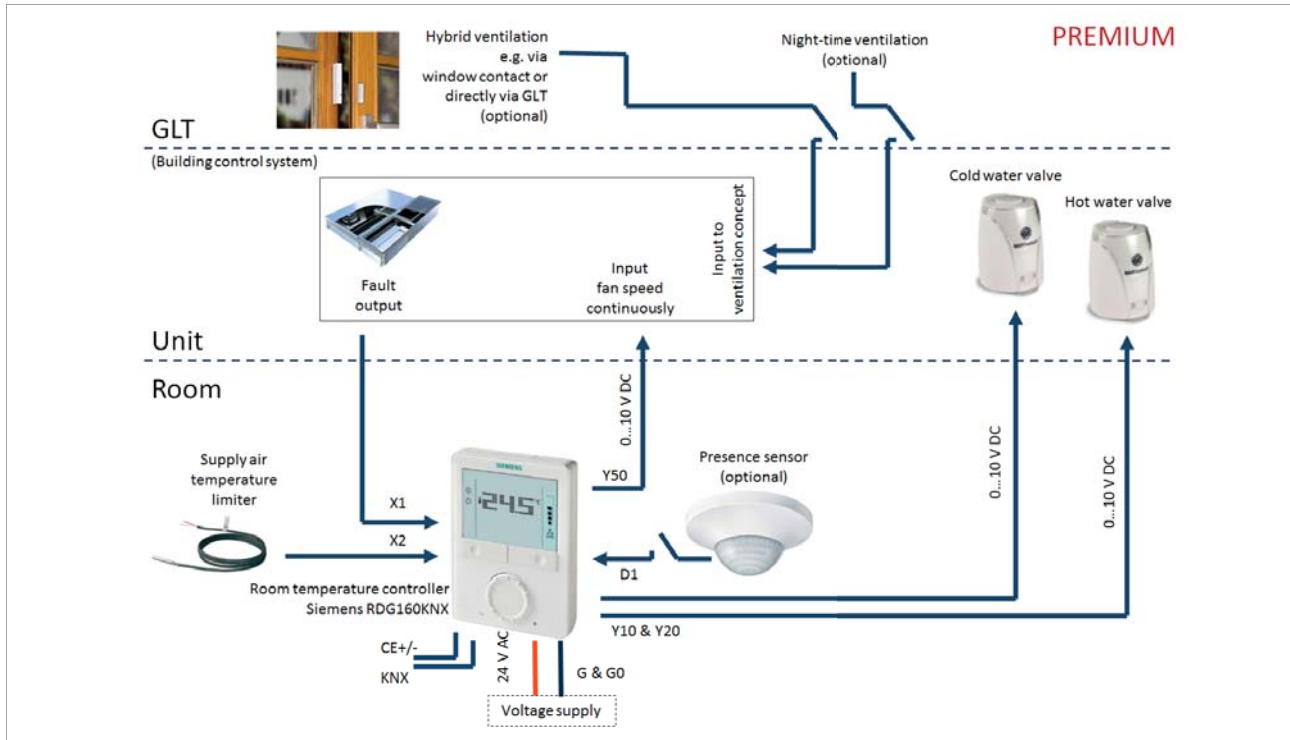

The continuous control of the EC fan in the „Premium variant“ means that there are even more possibilities when the unit is used in combination with the RDG 160 KNX control. Because the fan and the valves are continuously controlled, particularly stable control over time is possible as indicated in the following diagram. Thanks to the optional presence sensor or „key-card“ contact, it is also possible to implement an automatic „deactivation“ mechanism.

The fan speed and the cold and hot water valves are automatically controlled in the light of the set temperature. If neither heating nor cooling are required, the fan continues to provide basic ventilation (configurable, e.g. 60 m<sup>3</sup>/h).

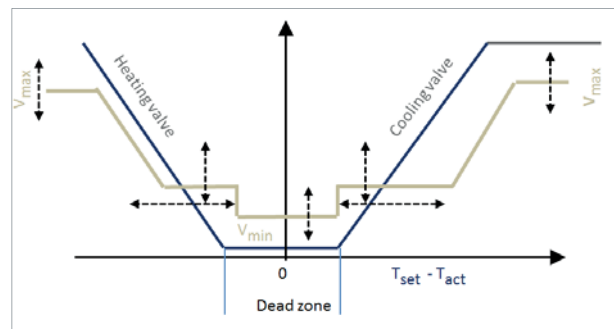

#### Heating

The fan speed is increased and the valves are opened.

#### Cooling

- low cooling requirement (0...48 % of cooling capacity)  
cooling valves are opened,  $V$  remains set to  $V_{min}$
  - high cooling requirement (52...100 % of cooling capacity)  
cooling valves are fully opened,  $V$  rises to  $V_{max}$
- + reduced energy consumption  
+ improved thermal / acoustic comfort (supply air temperature limitation)  
+ reduced air volume

## Technical brochure

# Decentralised ventilation units *FVPpulse -V*, sill installation

## Example Premium regulator/control: CO<sub>2</sub>-demand-controlled ventilation

Simple control diagram with room and building control system (GLT) options

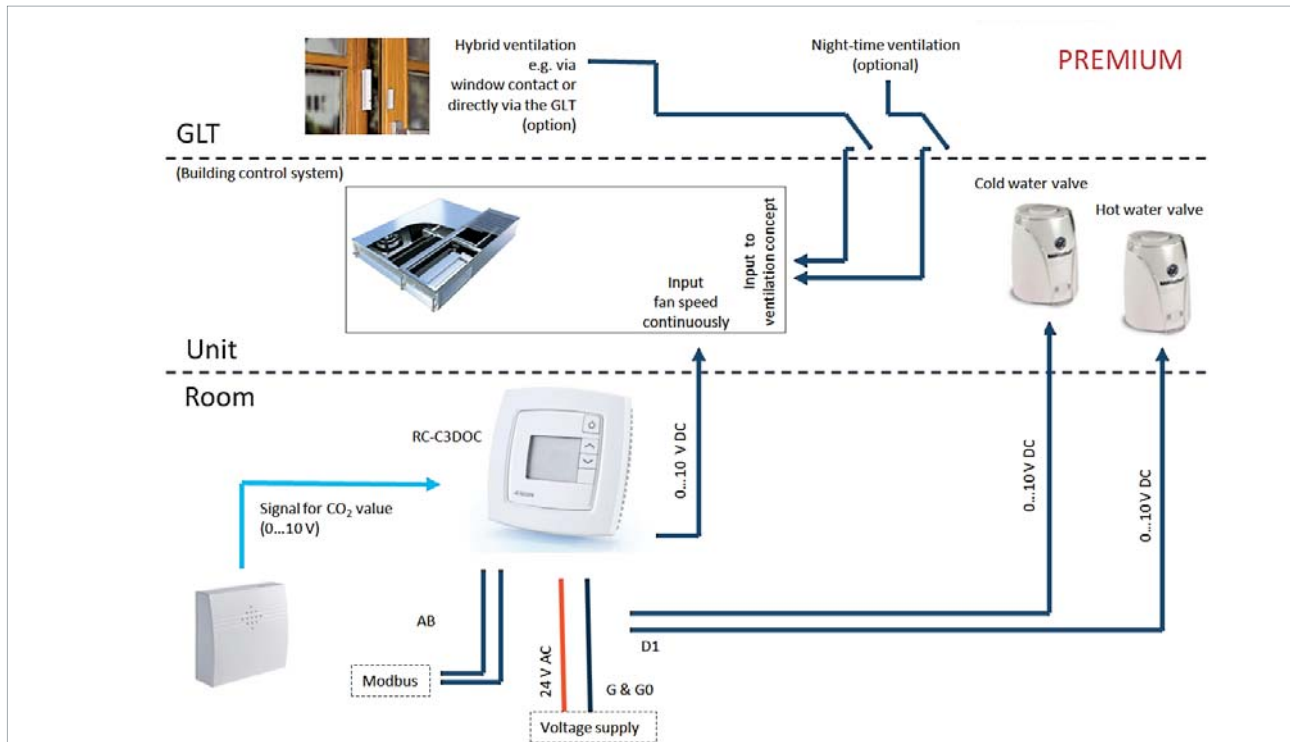

The use of an RC-C3DOC control makes other possibilities available for CO<sub>2</sub>-dependent demand-controlled ventilation. The fresh air volume is regulated depending on the air quality and the cooling/heating requirement. **Two control circuits are needed** for this:

### CO<sub>2</sub> control circuit

A CO<sub>2</sub> sensor measures the current CO<sub>2</sub> value and sends this to the RC-C3DOC room temperature control as a signal of 0...10 V. This compares the current actual value with the set value and regulates the necessary fresh air volume on this basis. The result is high air quality due to the regulation of the CO<sub>2</sub> value.

### Temperature control circuit

If the cooling requirement is low then a cooling process is initiated using cold water. In this case, the volume flowing through the system is continuously adapted to the cooling requirement. If the temperature rises further then the cooling capacity is increased by increasing the air volume flow. This type of control is particularly suitable when there are high requirements in terms of acoustics, thermal comfort, energy consumption and air quality. This control is also Modbus-compatible. As a result, many of the parameters can be set via the building control system, e.g.

- Set room temperature
- Energy saving mode
- etc.

It is possible to read, for example:

- Actual room temperature
- CO<sub>2</sub> content
- etc.

### Further advantages

- Reduced energy consumption
- The best possible thermal and acoustic comfort at all times
- Reduced air volumes
- Optimum air quality



## Technical brochure

### Decentralised ventilation units *FVPpulse -V*, sill installation

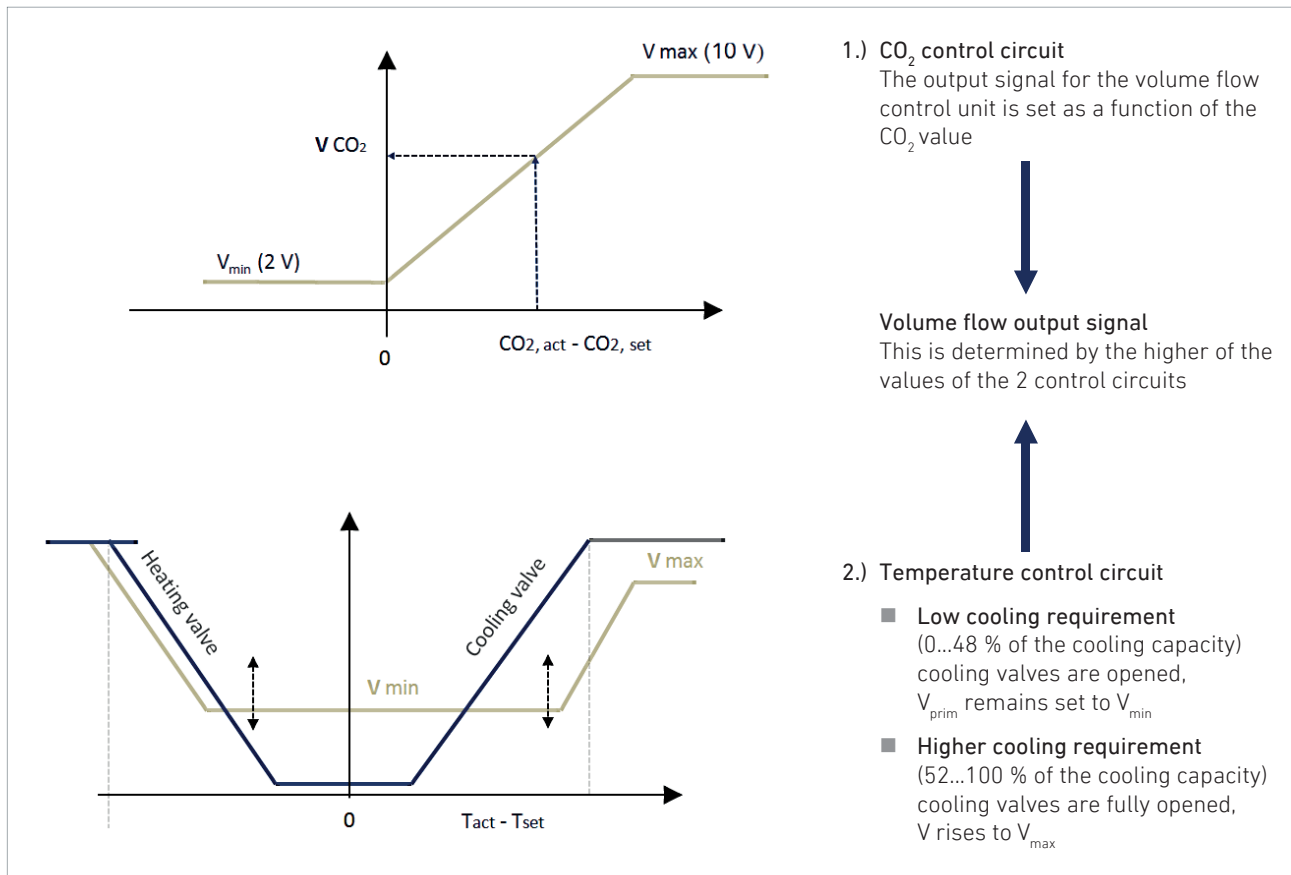

## Technical brochure

# Decentralised ventilation units *FVPpulse -V*, sill installation

### Master-slave combinations

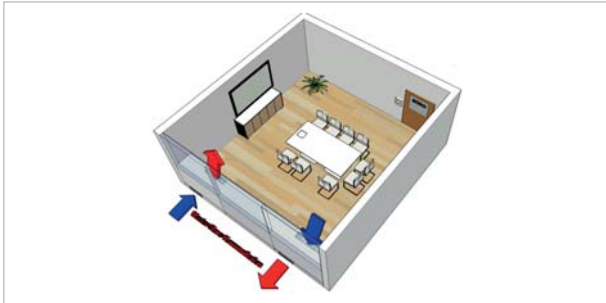

Each master unit is connected to a maximum of one slave unit.

If, for example, two units are installed in each room and there is no overflow port, then the „master unit“ must communicate with the „slave unit“. This communication takes place over a commercially available Ethernet cable. In this type of application, it is only necessary to control one unit (the master unit) as the slave unit then works in the opposite mode to the master. In this case, control inputs at the slave are not processed.

This configuration ensures that no over-pressure or under-pressure occurs in the room. The configuration (definition of the master and slave unit) is specified via the USB port.

### Control of the ventilation concepts

Operating mode	Control without GLT	GLT	Input at board	Signal
Standard (cyclical operation)	Set value at master; slave in opposite mode	Set value at master; slave in opposite mode	ST 1, 2, 3 (ECO control)	L (230 V AC, 50 Hz)
			Volume flow constant (Premium control)	1...10 V DC
Hybrid ventilation	Window contact at supply air input ("BZ") at master; slave in same mode (supply air) *	Window contact at GLT; GLT at supply air input at master ("BZ"); slave in same mode (supply air) **	Supply air mode "BZ"	L (230 V AC, 50 Hz)
Night-time ventilation ***	Not recommended	Depending on installation location, signal from building control system to supply air mode ("BZ") or exhaust air mode ("BA") ***	Supply air mode ("BZ") or exhaust air mode ("BA")	L (230 V AC, 50 Hz)

\* In the winter, there is a risk that the heat recovery unit may freeze if the window is open.

\*\* The building control system (GLT) should only permit hybrid ventilation in the summer because there is a risk that the heat recovery unit may freeze if the window is open in the winter.

\*\*\* If, for example, the master unit is switched to supply air mode („BZ“), then the slave unit operates in exhaust air mode without receiving a control signal.

#### Note

Master-slave communication in combination with the control inputs (BZ) for supply or waste air (BA) can only be configured in such a way that the „slave unit“ (in both operating modes) operates only in the opposite mode to the master unit (standard) or in the same mode as it. This means, for example, that hybrid ventilation and night-time ventilation using two units per room without overflow ports is not possible.

## Technical brochure

# Decentralised ventilation units *FVPpulse -V*, sill installation

### Wiring diagram

The board is located in the device. Viewed from the room, it is on the left under the tread-resistant ventilation grille.

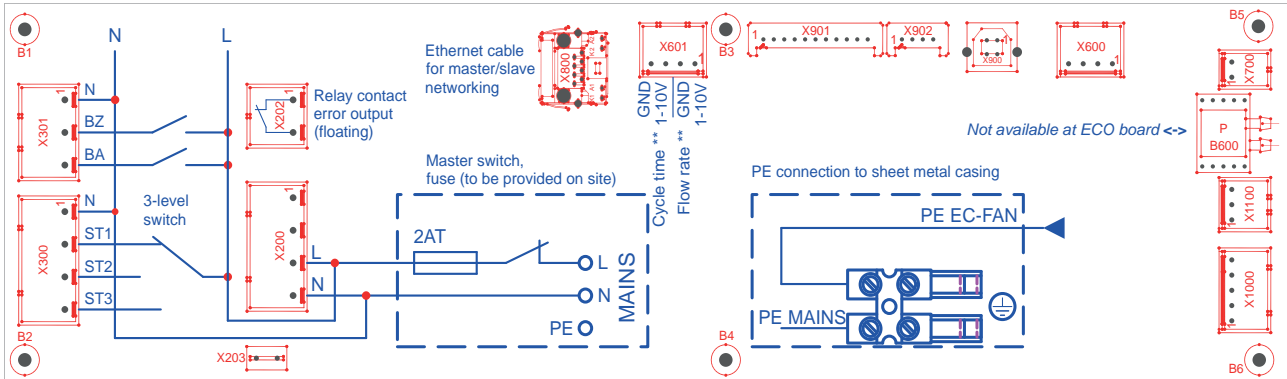

### Electrical specifications of the plug-in connection

Designation	Spring-loaded terminal blocks	Connector number	Module dimension, orientation	Voltage / specification
Error output	Pico Max Wago	X202	MD 7.5 mm Orientation 180 °	230 V AC 50...60 Hz
3-level switch		X300		
Mains supply		X200		
Operating mode (BZ, BA)		X301		
Flow rate / cycle time **		X601 *	MD 3.5 mm Orientation 180 °	0...10 VDC $R_{in}$ approx. 30 K-Ohm
USB service port	USB type B socket	X900	Orientation 180 °	
Networking	Ethernet cable	X800	Orientation 90 °	

\* The 0...10 V signals must be transmitted via a screened cable

\*\* Not available at ECO board

### Technical data

Voltage supply Control	230 V AC (+ 10...15 %) 50...60 Hz
Power consumption, control	max. 35 W
Switch outputs	230 V AC
Switching capacity of error relay	max. 2000 VA/10 A
Switching capacity of fan relay	max. 2000 VA/10 A
<b>Temperature ranges</b>	
Storage temperature	-20...+70 °C
Operating temperature	0...+50 °C

### Wiring

- Local regulations relating to wiring, fuses and earth bonding must be adhered to.
- The cables to the unit carry a mains voltage of 230 V AC and must be dimensioned accordingly.
- The supply cable must be protected by an external fuse or a circuit breaker.
- The lines for the control voltages (0-10 VDC, for example for flow rate / damper rest time) must be equipped with adequate cable screening.

### Error output

The (floating) error output closes if

- the frost protection function is triggered
- an internal cable breakage occurs
- internal components malfunction
- an impermissible command is received (e.g. supply and exhaust mode selected simultaneously)
- there is no voltage supply to the unit

A more detailed analysis of the fault can then be performed via the USB port.

## Technical brochure

# Decentralised ventilation units *FVPpulse -V*, sill installation

## Example facade installation

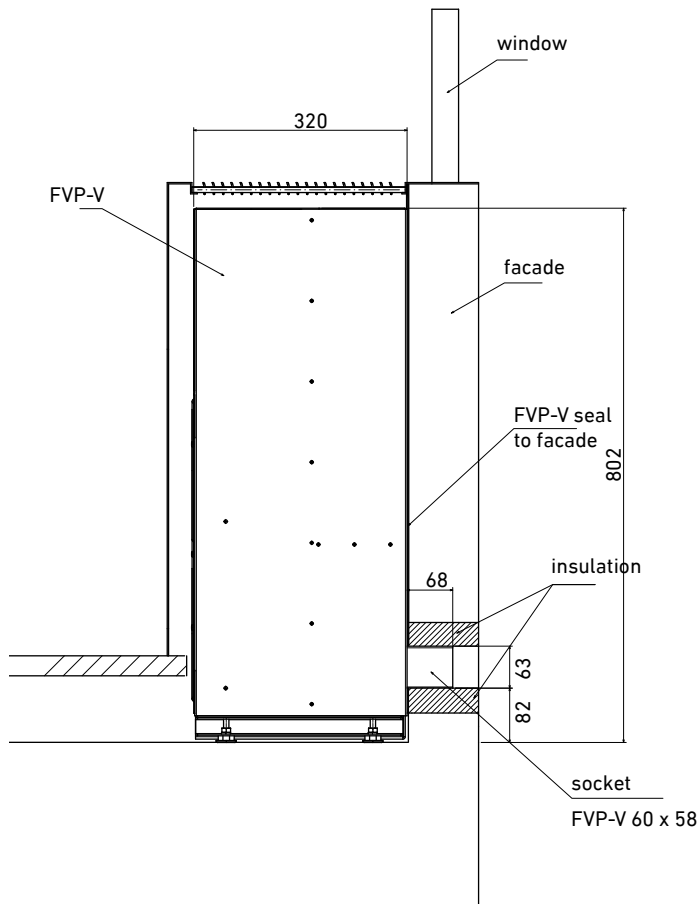

This figure presents an example of a typical facade installation. Thanks to the adaptable adjustable feet, the construction tolerances can be optimally compensated for.

With the unit, LTG also supplies a „soft-pad“ that performs the following tasks:

- Absorption of relative movements
- Structure-borne sound isolation
- Sealing of the facade against the housing
- Prevention of thermal bridges between unit and facade









We also recommend using a sheet metal duct that should meet the following specifications:

- recommended clear cross-section 610 x 63 mm (width x height)
- Ideally with a flange for sealing at the unit
- With insulation to prevent thermal bridges in the ventilation duct
- The socket should be inserted in the wall opening and be able to move.

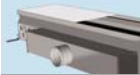

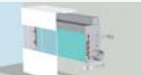



The figure does not take account of an oblique rain shield that should be mounted at the building. This can, for example, take the form of a waterproof grille and must provide for a slight incline (2...5 %) in the sheet metal duct.

## Product Overview - LTG Air-Water Systems

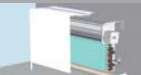



### LTG Induction – Induction Units

Ceiling Installation		Sill Installation		Floor Installation	
	HFF <i>suite</i> SilentSuite		HFV / HFV <i>sf</i> System SmartFlow		HFB / HFB <i>sf</i> System SmartFlow
	LHG System Indivent		HFG		
	HDF / HDF <i>sf</i> System SmartFlow		QHG		
	HDC				

### LTG FanPower – Fan Coil Units

Ceiling Installation		Sill Installation		Floor Installation	
	LVC System Indivent		VFC		VKB
	VKH		QVC		SKB
	VKE				
	KFA <i>CoolWave</i>				

### LTG Decentral – Decentralised Ventilation Units

Ceiling / Wall Installation		Sill Installation		Floor Installation	
	FVS Univent		FVP <i>pulse-V</i> System PulseVentilation		FVP <i>pulse-B</i> System PulseVentilation
					FVD / FVDplus

## Engineering Services





**AIR TECH  
SYSTEMS**

### **Comfort Air Technology**

Air-Water Systems  
Air Diffusers  
Air Distribution

### **Process Air Technology**

Fans  
Filtration Technology  
Humidification Technology

### **Engineering Services**

Laboratory Test / Experiment  
Field Measurement / Optimisation  
Simulation / Analysis  
R&D / Start-up

#### **LTG Aktiengesellschaft**

Grenzstrasse 7  
70435 Stuttgart  
Germany  
Tel.: +49 711 8201-0  
Fax: +49 711 8201-720  
E-Mail: [info@LTG.net](mailto:info@LTG.net)  
[www.LTG.net](http://www.LTG.net)

#### **LTG Incorporated**

105 Corporate Drive, Suite E  
Spartanburg, SC 29303  
USA  
Tel.: +1 864 599-6340  
Fax: +1 864 599-6344  
E-Mail: [info@LTG-INC.net](mailto:info@LTG-INC.net)  
[www.LTG-INC.net](http://www.LTG-INC.net)